

**FIXED PIER, SHORT**  
U5541

**FINISH**  
Anodized: Silver, Black  
(over machined aluminum)

**INCLUDES**  
Short (upper) Pier and mounting hardware.  
(#6 x 2 in. wood screw, #6 x 1¼ in. sheet metal screw and TripleGrip™ anchor)

**NOTE**  
The Fixed Pier, Short is rated for 150 lbs. when installed by fastening into structural wood with the appropriate fastener and the fastener is engaged 1" or more into lumber. However, the weight capacity of an individual pier/steel cable combination may be as low as 10 lbs., or less (static load), depending on the mounting hardware and installation technique. Actual capacity is dependent upon the installation. It is the responsibility of the installer to select the correct fastener for a particular installation.

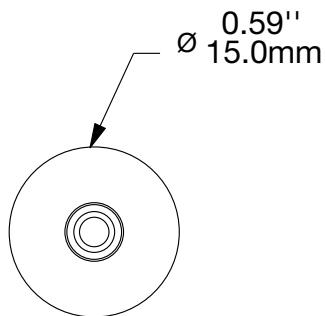
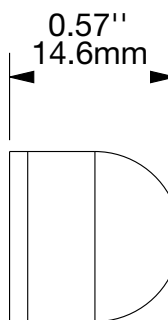
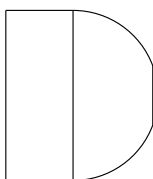
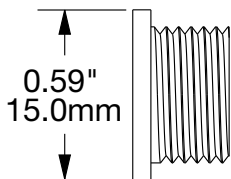

(Top view)

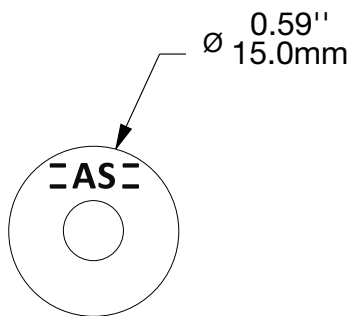

(Mounting surface)

ASHanging.com  
866.935.6949



**FIXED PIER, SHORT, W/ MOUNTING PLATE ROUND**

U5542

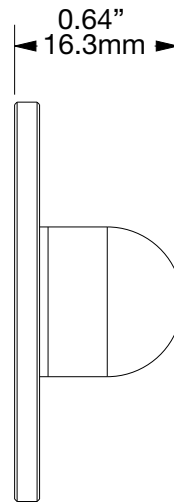
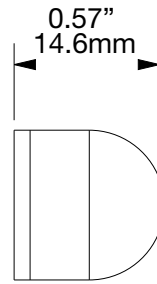
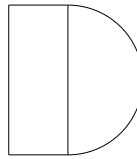
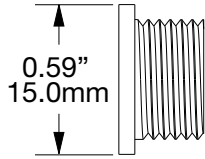
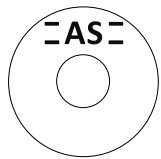
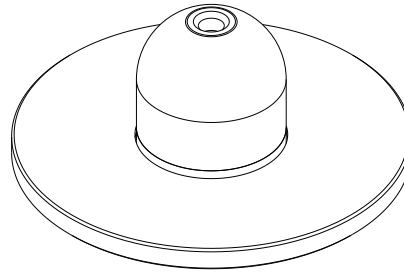

**FINISH**

Anodized: Silver, Black (over machined aluminum)

**INCLUDES**

Short (upper) Pier, Mounting Plate Round, and mounting hardware. (#6 x 2 in. wood screw, #6 x 1 1/4 in. sheet metal screw, Triple-Grip™ anchor, Spring Toggle Bolt).

**NOTE**

The Fixed Pier, Short is rated for 150 lbs. when installed by fastening into structural wood with the appropriate fastener and the fastener is engaged 1" or more into lumber. However, the weight capacity of an individual pier/steel cable combination may be as low as 10 lbs., or less (static load), depending on the mounting hardware and installation technique. Actual capacity is dependent upon the installation. It is the responsibility of the installer to select the correct fastener for a particular installation.

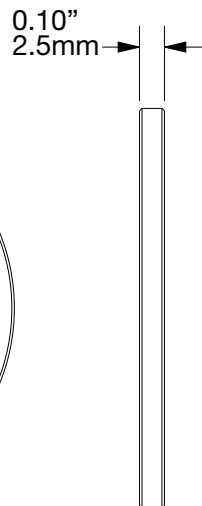

1.57" Ø 40.0mm

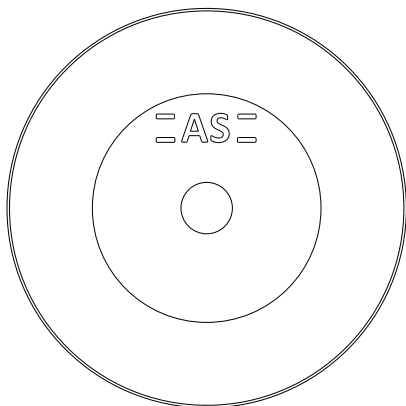

(Mounting surface)

ASHanging.com  
866.935.6949



**FIXED PIER, SHORT, W/ MOUNTING PLATE HALF MOON**  
U5543

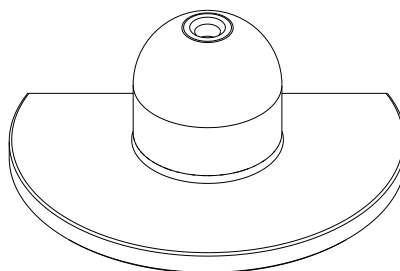

**FINISH**

Anodized: Silver, Black (over machined aluminum)

**INCLUDES**

Short (upper) Pier, Mounting Plate Half Moon, and mounting hardware. (#6 x 2 in. wood screw, #6 x 1 1/4 in. sheet metal screw, TripleGrip™ anchor, Spring Toggle Bolt).

**NOTE**

The Fixed Pier, Short is rated for 150 lbs. when installed by fastening into structural wood with the appropriate fastener and the fastener is engaged 1" or more into lumber. However, the weight capacity of an individual pier/steel cable combination may be as low as 10 lbs., or less (static load), depending on the mounting hardware and installation technique. Actual capacity is dependent upon the installation. It is the responsibility of the installer to select the correct fastener for a particular installation.

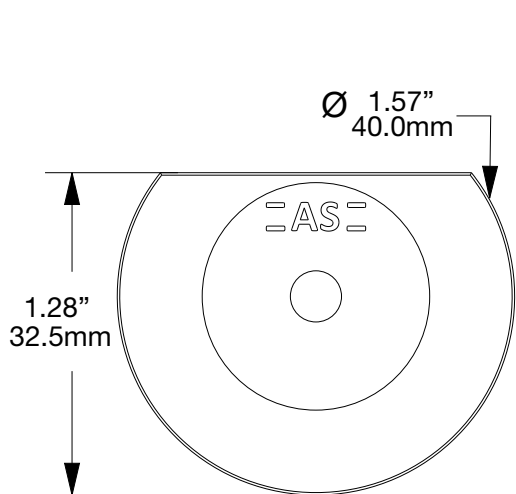
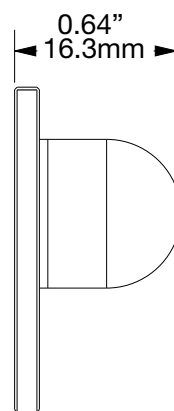
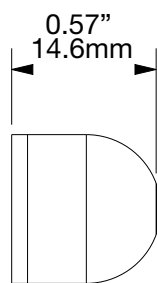
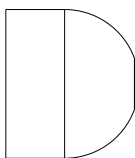
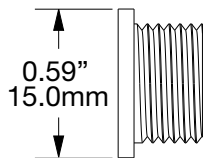
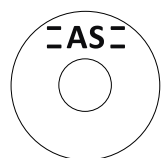

(Mounting surface)

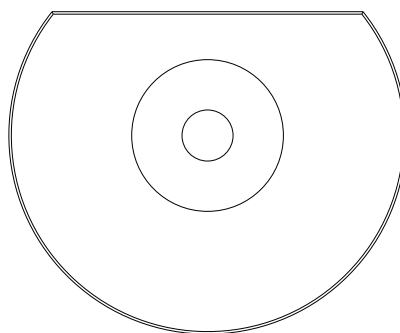
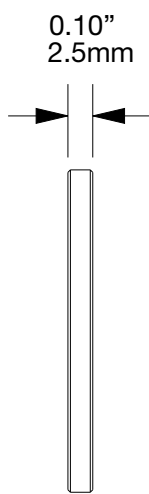

ASHanging.com  
866.935.6949