



TOP-BOTTOM CLAMP, SMALL H3070



WEIGHT CAPACITY*
150 lbs
68 kg

FINISH
Anodized, Brushed aluminum
Set screws are stainless steel

INCLUDES
Glass Bushings (4x)
Allen Key, 2mm

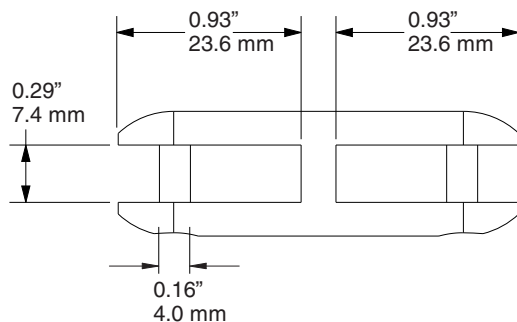
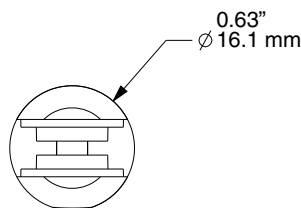
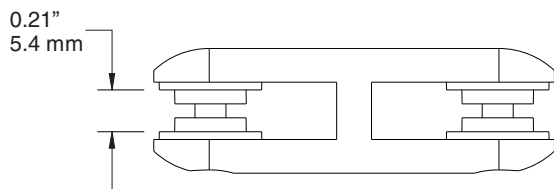
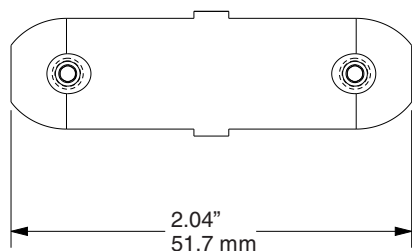
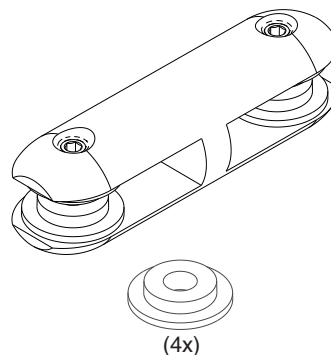

NOTE
Supplied with flat tipped set screws that must engage both walls of the clamp. Materials used in the clamp are to be prepared with through holes. Supplied bushings are to be used with glass, or other delicate panels. Glass panels are to be tempered monolithic glass.

*This value is subject to the strength of the panel and assumes the panel is capable of this load without deformation or failure.

ASHanging.com
866.935.6949



TOP-BOTTOM CLAMP, MEDIUM H3071



WEIGHT CAPACITY* 150 lbs 68kg

FINISH Anodized, Brushed aluminum Set screws are stainless steel

INCLUDES Glass Bushings (4x) Allen Key, 2mm

NOTE Supplied with flat tipped set screws that must engage both walls of the clamp. Materials used in the clamp are to be prepared with through holes. Supplied bushings are to be used with glass, or other delicate panels. Glass panels are to be tempered monolithic glass.

*This value is subject to the strength of the panel and assumes the panel is capable of this load without deformation or failure.

ASHanging.com 866.935.6949

