

Click Rail Track A1050

FINISHED CARPENTRY INSTALLATION

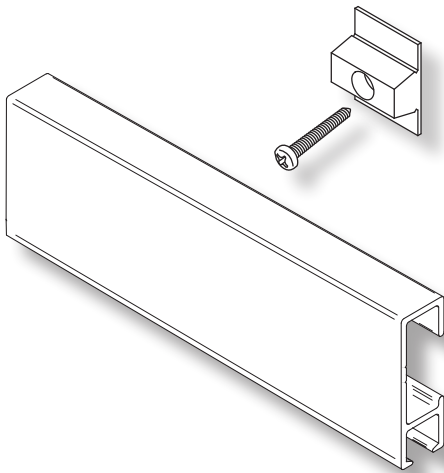
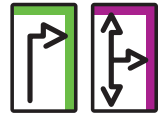

Warning

The track is supplied with screws, plastic screw anchors and mounting clips (Click & Connect Connectors) that are suitable for mounting the track to wall-board, lath and plaster, concrete, masonry block, structural lumber and metal studs. All mounting clips must be used and spaced evenly along the length of the track.

Serious property damage and personal injuries can occur from track mount failure. To prevent such failure it is the responsibility of the installer to select a suitable fastener for a particular installation.

Please refer to Standard Installation Guide for Click Rail Track for basic installation steps. That guide should be referred to prior to viewing this guide. This guide should be viewed as an addendum and specialized for installations in conjunction with finished carpentry.

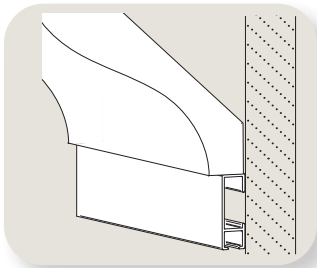

1 Basic Install Below Molding

- The most basic, and predictable, installation is to mount the track immediately below an existing crown molding. Installation is just as communicated in the Standard Installation Guide.

Track in Relation to the Crown Molding

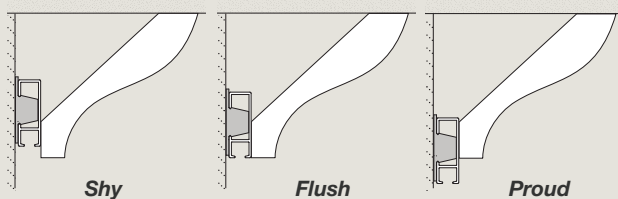

2 Face Mounted Molding

- It is possible to mount Click Rail Track and subsequently attach crown molding, or other finished carpentry such as a wall molding, to the face of the track. The company's patented Twist-End Cables uniquely enable the track to be shy of the lowest edge of the molding treated in this method.

3 Rabbet into Moulding

- Another approach is to route a rabbet in the rear side of finished carpentry, within which to "hide" the track. Here a wall molding detail, common in Prairie Style, Craftsman Period and Frank Lloyd Wright Style, was prepared in this manner.

TIP

The track, when installed in this manner, may be mounted with a supplied clip or reversed and mounted directly for additional strength.

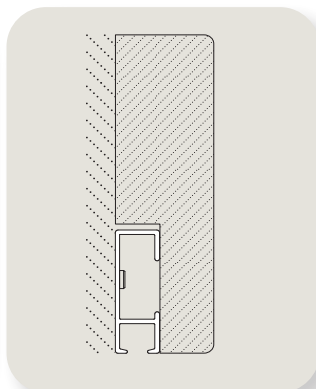
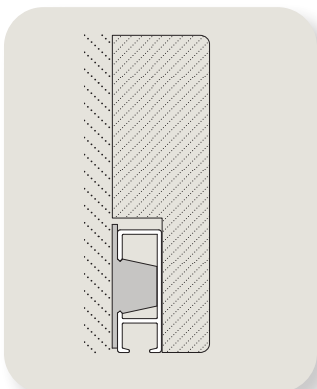

4 Fastening Molding

- Moulding may be attached to Click Rail Track by use of
 - Readily available construction adhesive
 - Or, a combination of finish nails and adhesive.

 Guard against excess adhesive or nails entering the track lower opening.

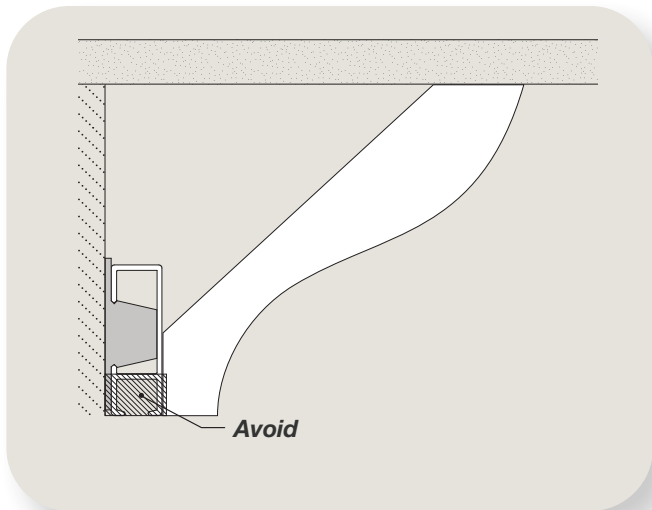

 If fasteners are used, avoid driving a nail into a mounting clip.

